

## Key Features:

- 220VAC Continuous Input Voltage
- **VITA 62.2 specification compatible**
- 2300V Isolation Between Input /Output
- Active Input EMI Filtering
- Transient look ahead/cut-off technology
- 6 Voltage output Rails
- Isolated 3.3V aux standby feature
- 600W Maximum Power, NO PFC stage
- 92% Typical Efficiency
- -40°C to 85°C Rail Operating Temperature
- VITA 62 3U Form Factor
- VITA 46.11 ready
- Patent pending **FourRail** thermal interface
- [SMART.PSU] Technology

## VITA 62 3U ISOLATED 600W 220VAC POWER SUPPLY

This 3U power supply works with **220VAC input** voltage at input frequencies from **40Hz to 70Hz** and isolates the input voltage ground from the output voltage ground. The power supply is **conduction cooled**, uses **polyphase** technology on all voltage rails and can provide up to **600 watts**. It is suitable for use in **mission critical rugged applications**.

[SMART.PSU]PCI-Systems Inc. intelligent power supplies integrate a **microcontroller (MCU)** for a fully programmable and flexible solution. Intelligent power conversion allows **configuration and reconfiguration** for different applications. With intelligent power conversion, the power supply becomes a platform solution for Vita 46.11 system management based systems. The power supply can easily be **reprogrammed** to support different **operating limits and control inputs**.

### Features:

- Parallel operating with multiple power supplies, all rails
- Load sharing and balancing
- Digital On/Off control for low standby power
- Input / Output Voltage rail setting /adjustment
- Spread Spectrum Clocking of power supply stages
- Possibility of external synchronization
- Power supply sequencing and hot-swap control
- Power supply history logging and fault management
- Monitoring all input/output voltages, currents and power
- Current fold back control
- Automatic temperature drift compensation for all outputs
- Total-Elapsed-Time Recorder
- Efficiency calculations at any time
- Communication via SMB/I2C (PMB)for Vita 46.11 system management
- Collects data from temperature sensors for over temperature protection
- Precision compensation of all output voltages using integrated 5ppm voltage reference

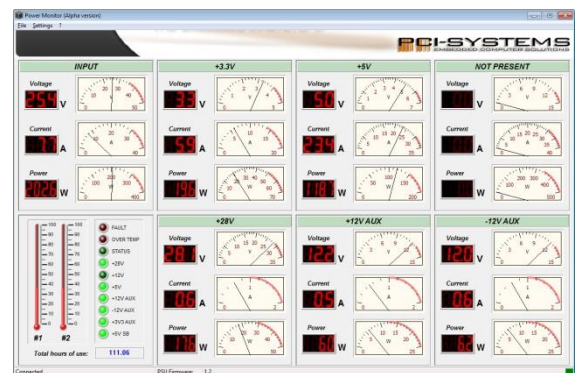

Overview	
P/N	<b>PCI_800.155</b>
Hold Up time	<b>3ms</b>
VITA Compliant	<b>VITA62</b>
Size	<b>3U</b>
Temp. Range	<b>-40 +85 C</b>
Input (AC or DC)	<b>AC</b>
Input Range (VDC)	<b>220 nominal</b>
Active EMI Filtering	<b>YES</b>
Power (W, max.)	<b>600</b>
Efficiency (% , typ.)	<b>92</b>
# of outputs	<b>6</b>

OUTPUTS (Total output not to exceed 600W)	
VS1, V@A	<b>+12@40A</b>
VS2, V@A	<b>+3.3@20A</b>
VS3, V@A	<b>+5@40A</b>
AUX, V@A	<b>+3.3@4A</b>
AUX, V@A	<b>+12@1.5A</b>
AUX, V@A	<b>-12@1.5A</b>

FEATURES	
Over-current Protection	<b>YES</b>
Over-voltage Protection	<b>YES</b>
Over-temperature Protection	<b>YES</b>
Current Sharing	<b>VS1, VS2, VS3</b>
Remote Sense	<b>YES</b>
Standard Control	<b>YES, VITA62</b>
Extended Control	<b>YES, PCI Systems</b>

COMPLIANCE	
VITA62	<b>YES</b>
MIL-STD-704 (B-F)	<b>YES</b>
MIL-STD-461	<b>YES</b>
MIL-STD-810G	<b>YES</b>
* ESD Protection	<b>YES</b>
* Shock	<b>YES</b>
* Vibration	<b>YES</b>
* Rapid Decompression	<b>YES</b>
* Corrosion Resistance	<b>YES</b>
* Fungus Resistance	<b>YES</b>
* Altitude	<b>YES</b>
* Humidity	<b>YES</b>

INPUT CHARACTERISTICS					
Parameter	Min.	Typ.	Max.	Units	Notes
Absolute Maximum Ratings					
<b>Input Voltage</b>					
- Non-Operating	<b>-60</b>		<b>270</b>	V	Continuous
- Operating	<b>-40</b>		<b>264</b>	V	Continuous- Reverse input Protection
- Operating Transient Protection			<b>4590</b>	V	100ms transient, square wave
<b>Isolation Voltage</b>			<b>1500</b>	V	
<b>Operating Temperature</b>	<b>-40</b>		<b>85</b>	C	
<b>Storage Temperature</b>	<b>-55</b>		<b>105</b>	C	
Electrical Characteristics					
<b>Input Voltage</b>					
- Continuous	<b>200</b>		<b>254</b>	V	
- Transient	<b>200</b>		<b>450</b>	V	Transient for 100 ms
<b>Under-Voltage Lockout</b>					
- Turn-On Input Voltage Threshold	<b>190</b>	<b>220</b>	<b>270</b>	V	

INPUT VOLTAGE SPIKES SUPPRESSION (Vin Centered)	
+/- 450V, 100 us	MIL-STD-1275D
+/- 490V, 10 us	MIL-STD-461C (CS06); DEF-STAN 61-5
+/- 450V, 5 us	MIL-STD-461C (CS06)
+/- 600V, 10 us	RTCA/DO-160E

OUTPUT CHARACTERISTICS							
Parameter	+12V	+5V	+3.3V	+3.3V aux	+12V aux	-12V aux	Notes
Output Voltage Set Point, V	12	5	3.3	3.3	12	-12	Vin = 115VAC
- Drift -40 deg. C to 85degC +/- %	0.01	0.01	0.01	0.01	0.01	0.01	Vin = 115VAC
Output Voltage Trim Range, V	12	5	3.3	3.3	12	-12	Over Line/load/temp.
	+/- 10%	+/- 10%	+/- 10%	+/- 10%	+/- 10%	+/- 10%	Over Line/load/temp.
Output Voltage Ripple (pk-pk), mV	80	50	40	40	80	80	Full load with 1 uF + 10 uF tantalum capacitor at each slot
Operating Current Range, A	0-40	0-40	0-20	0-4	0-1.5	0-1.5	660W Total, combined Output
Over-Voltage Protection, V	13	6	3.6	3.6	13	13	
Current Limit Inception, A	41	41	21	4.1	1.7	1.7	
Maximum Output Capacitance, mF	10	10	10	1	1	1	

MODULE QUALIFICATION	
Test Name	Method
Random Vibration	MIL-STD-810, 514.6 - Procedure I, Class V3
Shock	MIL-STD-810, 516.6 - Procedure I, VI, Class OS2
Altitude	MIL-STD-810, 500.5 - Procedure I, II, III
Fungus Resistance	MIL-STD-810, 508.6
Corrosion Resistance	ASTM G85, Annex A4
Humidity	MIL-STD-810, 507.5 - Procedure II
High Temperature	MIL-STD-810, 501.5 - Procedure I, II
Low Temperature	MIL-STD-810, 502.5 - Procedure I, II
Temperature Cycling	MIL-STD-202, 107 - Class C4
ESD	EN61000-4-2, Level 4; 15kV Air Discharge

Calculated MTBF per MIL-HDBK-217F (GB) at 70 deg C. 2.100.000 Hrs.  
 Calculated MTBF per MIL-HDBK-217F (GM) at 70 deg C. 450.000 Hrs.

**Block Diagram:**

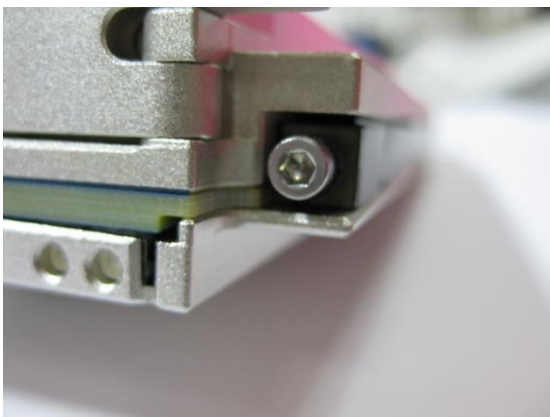
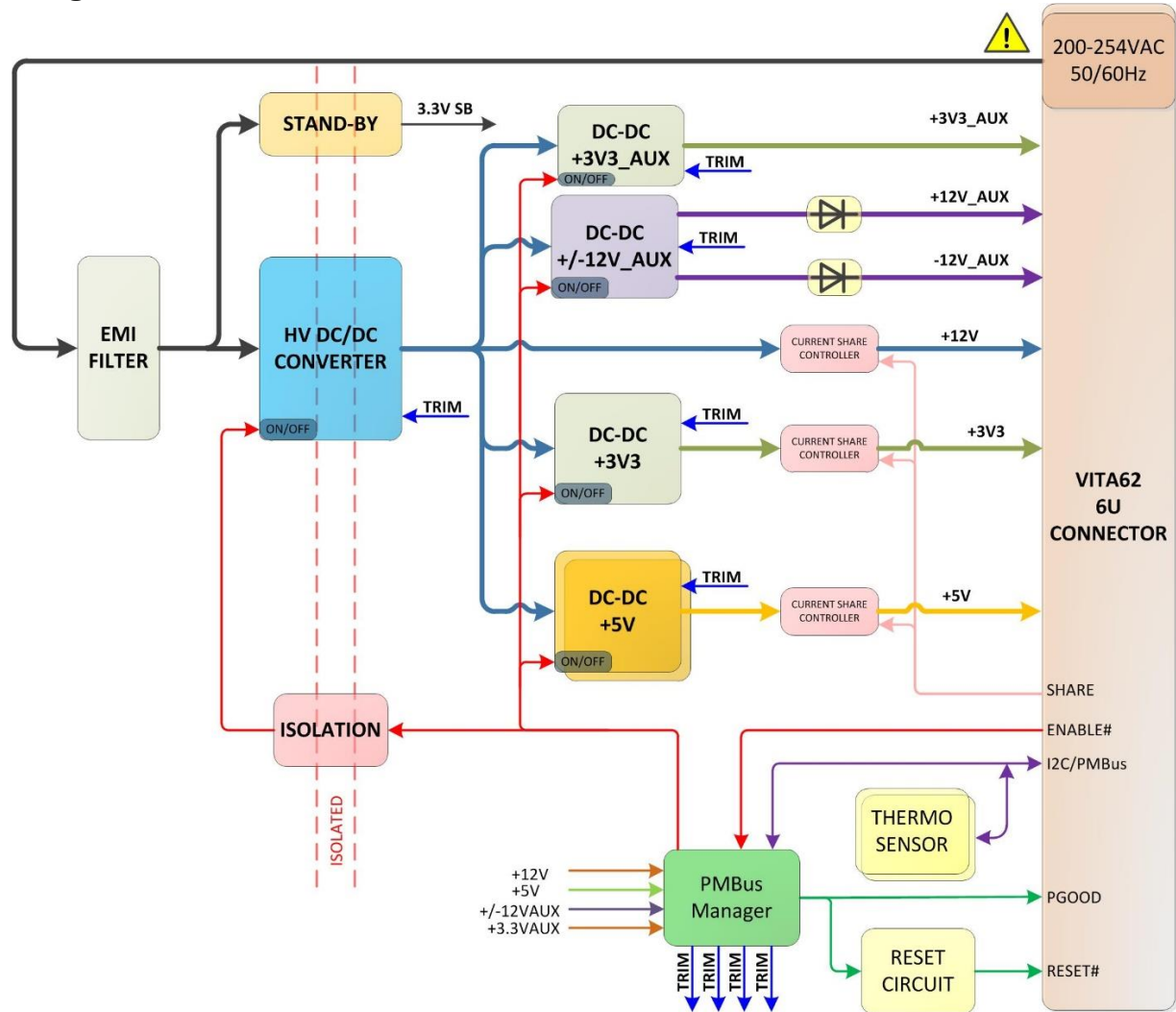

Patent pending 4 way heat transfer design adds 90 % more heat transfer surface.

New extractor design

N

Pinout: As per VITA 62.2 specification

Mechanical Dimensions: As per VITA 62 specification (1" pitch)

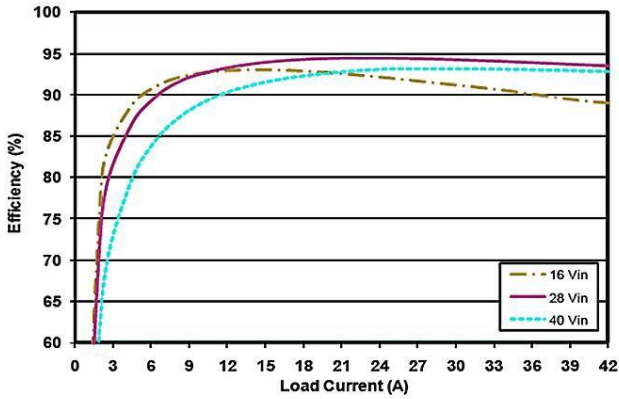

Efficiency at nominal output voltage vs. load current for min, nom, max input V at 25°C

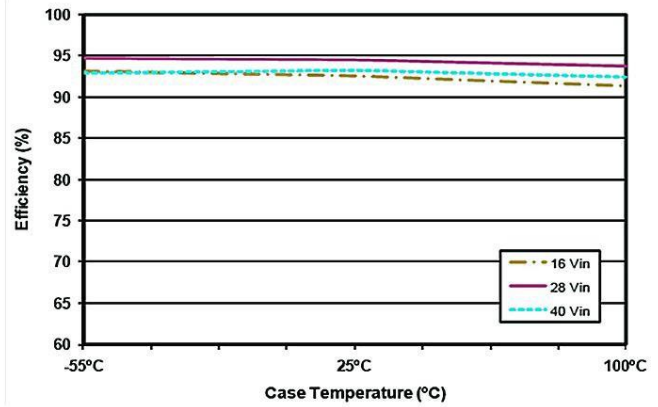

Efficiency at nominal output voltage and 60% rated power vs. case temp for min, nom, max input voltage

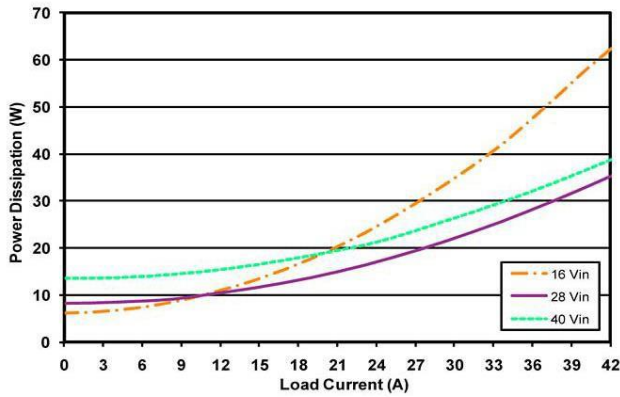

Power Dissipation at nominal output voltage vs. current at module cover 25°C (Delta T to wedgelock 7C°)

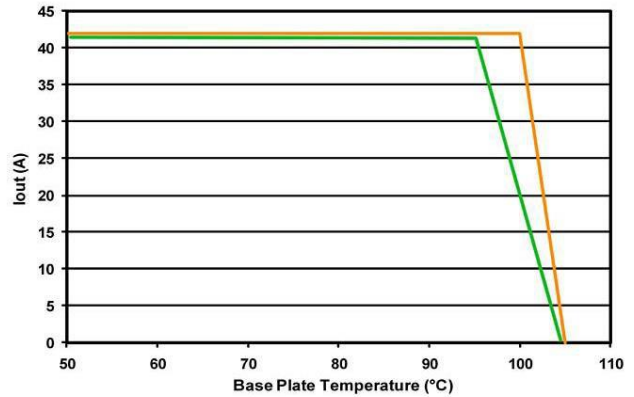

Thermal derating max current vs. temp at module cover. (Delta T to wedgelock 7C°)

**ORDERING INFORMATION:**

PCI\_800.155\_C 3U VITA 62 220VAC, without PFC stage 600W Isolated Rugged Power Supply with Conformal Coating

Release\_1.1\_2020